

30 min

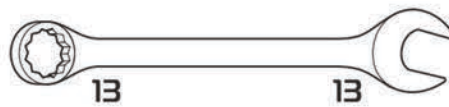

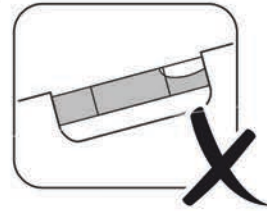
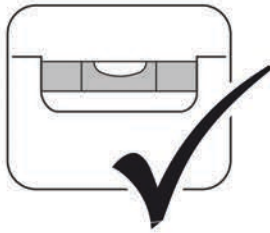
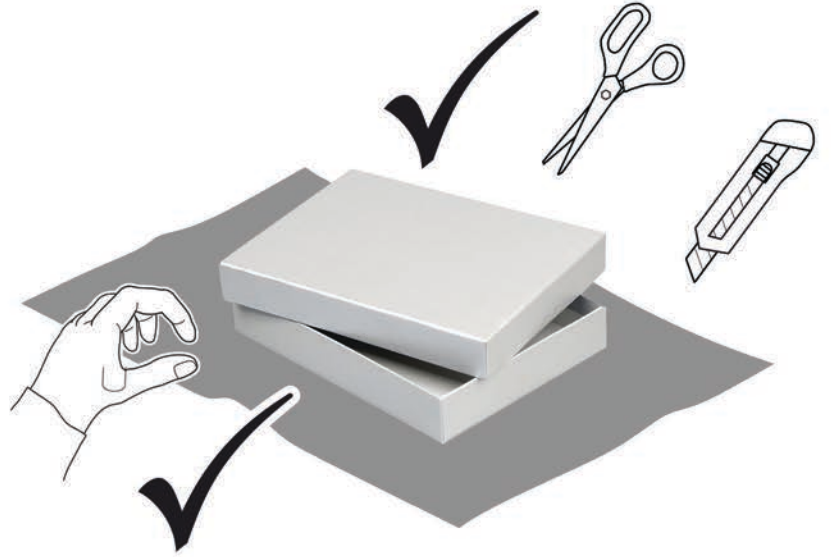
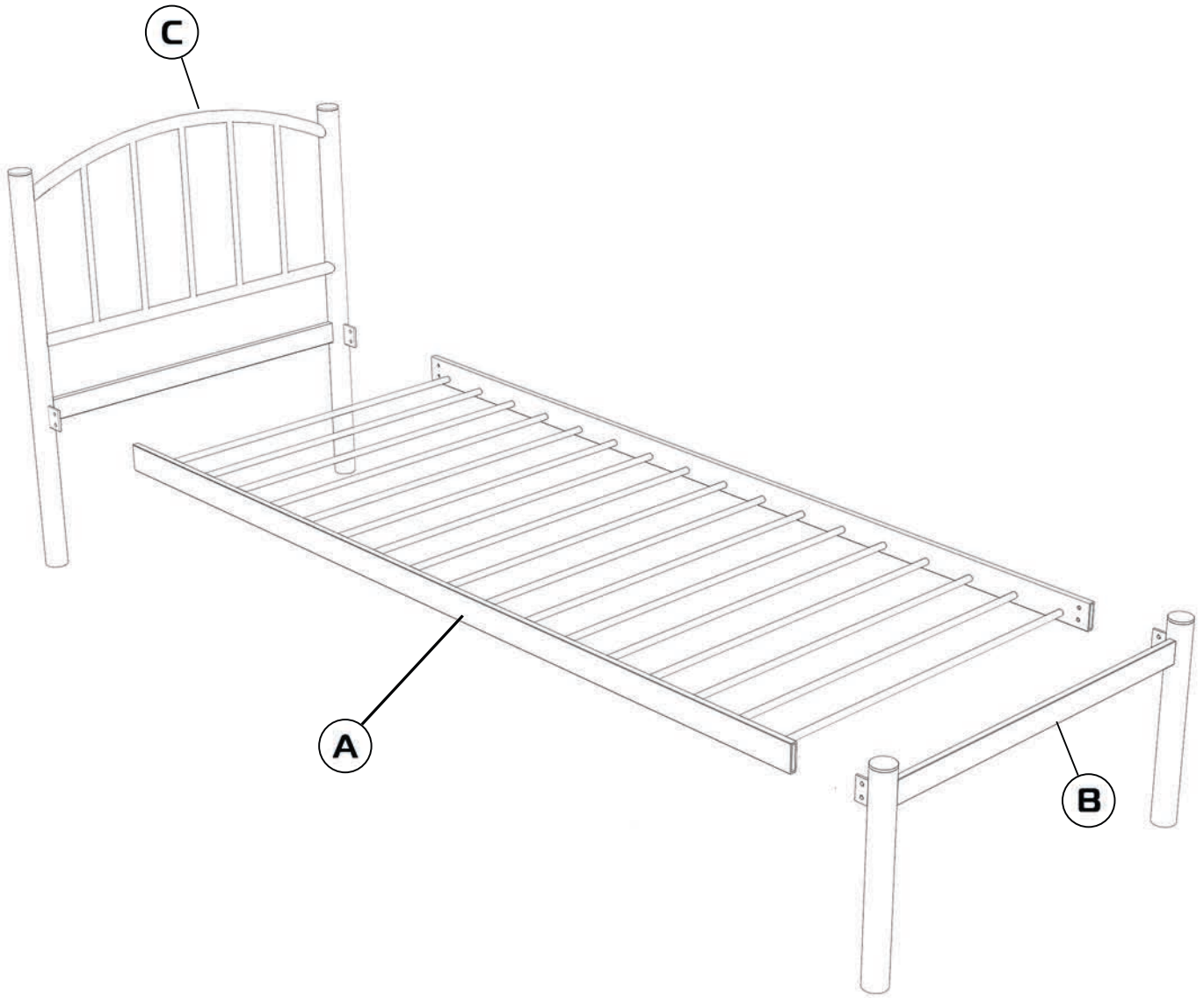

(A) x1 **(B) x1** **(C) x1**

1:2

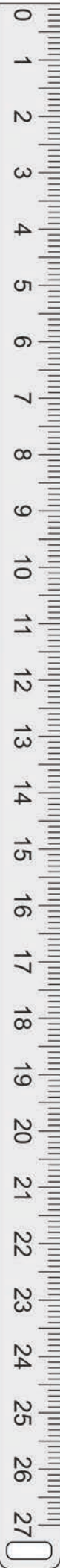
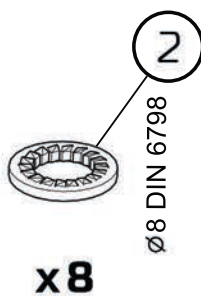
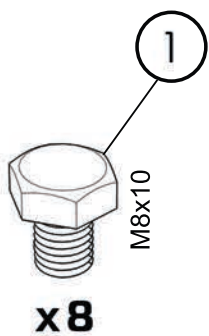

1

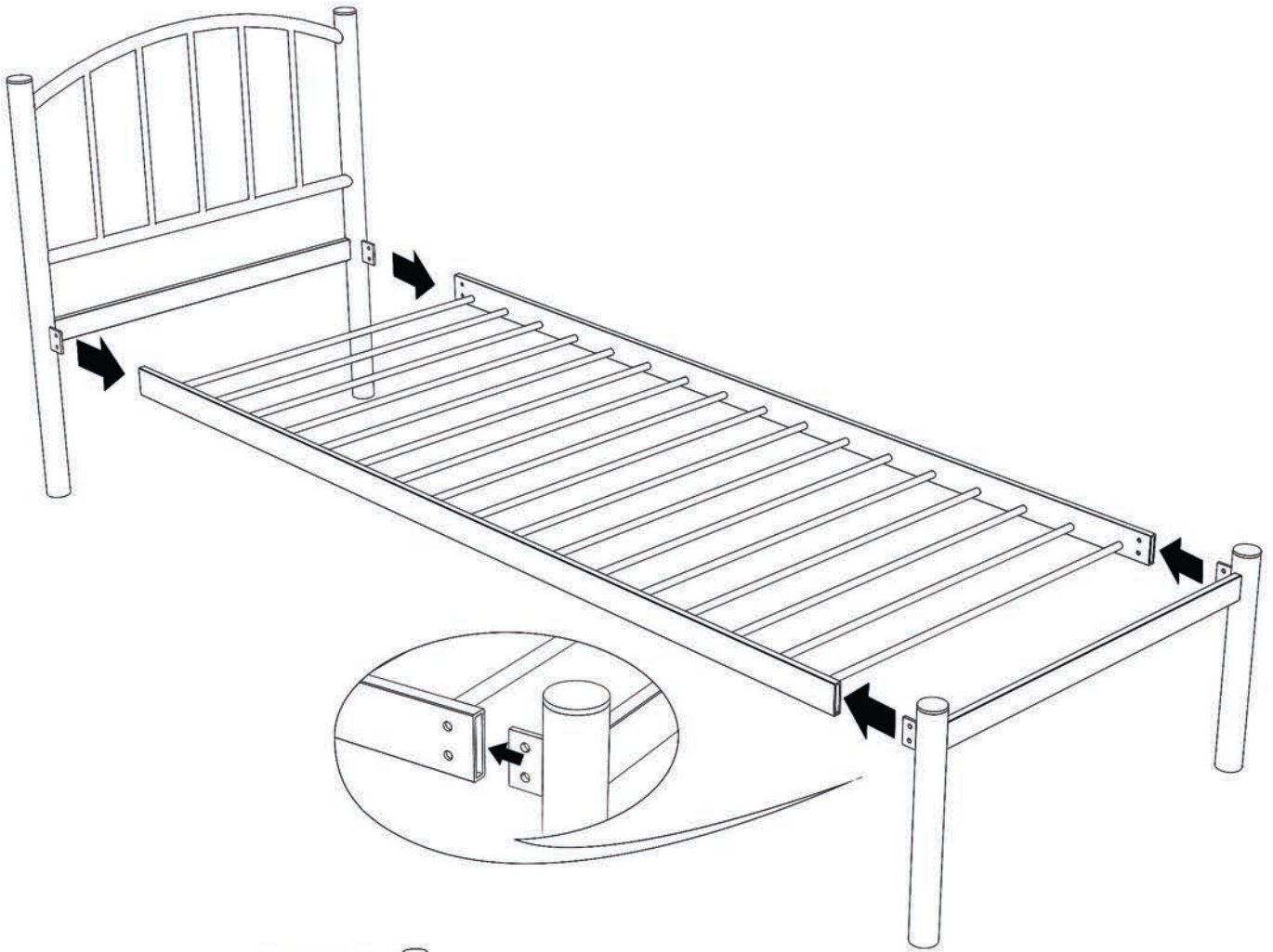

2

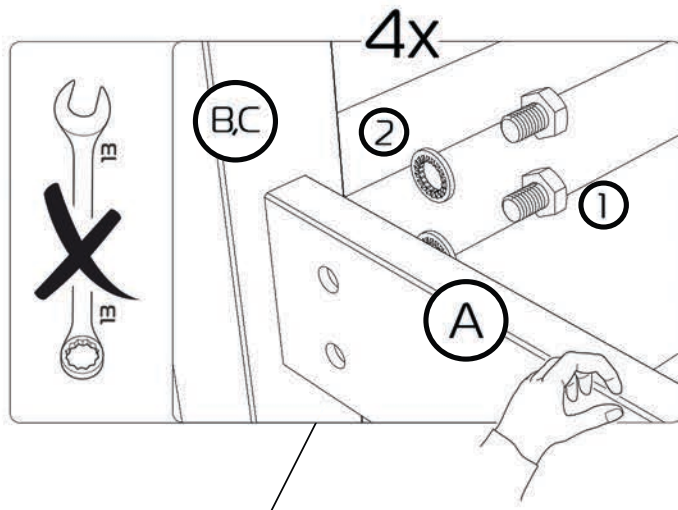

3

